

LINEA
CEILING & WALL SYSTEMS

FLEXIFELT



SCREENS



Introducing **FLEXIFELT**

LINEA **FLEXIFELT** SCREENS combine aesthetic appeal with outstanding acoustic performance, boasting a smooth, fabric-like finish. Crafted from PET (Polyethylene Terephthalate) material, this substrate is semi-rigid, lightweight, impact-resistant, and tackable, while maintaining exceptional acoustical properties suitable for both wall and ceiling applications.

FLEXIFELT is composed of 100% non-woven polyester fiber. Remarkably, at least 60% of this material is derived from post-consumer content, specifically recycled plastic beverage containers, rendering the panel 100% recyclable.

In addition to its eco-friendly composition, the **FLEXIFELT** material exhibits non-hygroscopic qualities, making it resistant to moisture absorption. It is also characterized as anti-microbial, anti-fungal, and free from volatile organic compounds (VOCs) such as formaldehyde. Available in a diverse range of colors, thicknesses, and applications.



LINEA FLEXIFELT



SCREENS

**Product information is subject to change without notice.*

T 604-776-2265 sales@lineaceilings.com lineaceilings.com 2320 Peardonville Road Abbotsford, BC Canada V2T 6J8



FLEXIFELT PRODUCT SPECIFICATIONS	
Acoustic Felt Type:	100% Polyester Fiber (60% PET–Recycled Fiber, 40% PET Virgin Fiber)
Fire rating:	Class A (ASTM E84)USA and CAN/ULC S102
Size:	1225mm x 2800mm (4' x 9' Nom)—Thickness 9mm and 12mm 1200mm x 2440mm (4' x 8' Nom)—Thickness 24mm
Edge:	Square or Beveled at 15°, 22.5°, 30° and 45°
Colours:	31
NRC Rating:	0.40–1.00 (depending panel thickness and mounting options)
Weight:	9mm (3/8")–1900g/m ² –0.39lb/ft ² 12mm (1/2")–2300g/m ² (0.47 lb/ft ²) 24mm (1")–3500g/m ² (0.72lb/ft ²)
Use:	Interior use only







FLEXIFELT SOLID PANEL NRC					
9mm Thickness		12mm Thickness		24mm Thickness	
Frequency/Hz	NRC	Frequency/Hz	NRC	Frequency/Hz	NRC
No cavity	0.35	No cavity	0.40	No cavity	0.60
		Cavity 25mm	0.65		
Cavity 50mm	0.65	Cavity 50mm	0.75	Cavity 50mm	0.75
Cavity 100mm	0.75	Cavity 100mm	0.80	Cavity 100mm	0.85
Cavity 150mm	0.80	Cavity 150mm	0.90	Cavity 150mm	0.90
Cavity 200mm	0.80	Cavity 200mm	0.90		
Note: NRC values illustrated are the average sound absorption coefficient from frequency 100 to 4000 Hz					
<p>Handling and Storage: FLEXIFELT possesses a semi-rigid structure, requiring careful handling and storage to prevent damage to the product. To ensure the integrity of the material, it is recommended to handle packaging and panels with care, carrying them vertically upright with the assistance of two tradespeople. For optimal preservation, panels should be stored indoors in a clean, dry, cool, and well ventilated environment, ensuring they are kept elevated above the floor or any surface emitting moisture. It is advisable to wear clean gloves during the handling process to prevent any soiling or marking of the product. Caution should be exercised to avoid bending or flexing the panels, as this may result in creasing. To further safeguard the material, it is important to steer clear of exposure to temperatures exceeding 150°F (65°C). Additionally, panels should not be stored in proximity to radiators, steam pipes, or direct sunlight, mitigating the risk of heat-related damage.</p> <p>Maintenance: Maintain regular cleaning by using a smooth attachment with low suction for vacuuming. We recommend seeking professional cleaning services periodically. Only use upholstery detergent; refrain from using dish washing or laundry detergents. Prior to reuse, ensure thorough drying away from direct heat.</p> <p>Warranty: Linea Ceiling and Wall Systems offers a two (2) year limited warranty effective from the date of installation, protecting against undue deterioration specifically attributable to faulty materials and manufacturing workmanship.</p>					

*Product information is subject to change without notice.

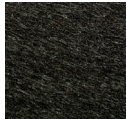

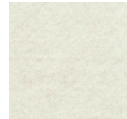
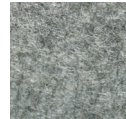

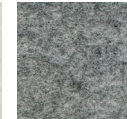





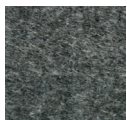





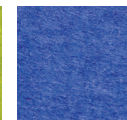

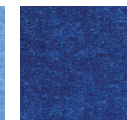

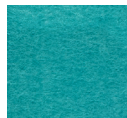
COLORS

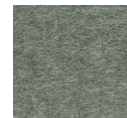

POPULAR COLORS

								
BLACK	CHARCOAL	WHITE	LIGHT GRAY	MARBLE	SNOW	CEMENT	BEIGE	SAND
9mm 12mm 24mm	9mm 12mm 24mm	9mm 12mm	9mm 12mm 24mm	9mm 12mm 24mm	9mm 12mm	9mm 12mm	9mm 12mm	9mm 12mm

OTHER COLORS

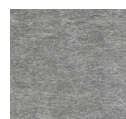
								
DARK GRAY	ICY	RED	ORANGE	YELLOW	GREEN	NAVY	BLUE	DENIM
9mm 12mm	9mm 12mm	9mm 12mm	9mm 12mm	9mm 12mm	9mm 12mm	9mm 12mm	9mm 12mm	9mm 12mm
								
DUSK	TURQUOISE	STORM	ECLIPSE	RIVER ROCK	DOLPHIN	JADE GRAY	GRANITE	TWEED
9mm 12mm	9mm 12mm	9mm 12mm	9mm 12mm	9mm 12mm	9mm 12mm	9mm 12mm	9mm 12mm	9mm 12mm
								
PLATINUM	SMOKE	STONE	PEWTER					
9mm 12mm	9mm 12mm	9mm 12mm	9mm 12mm					

DISCLAIMER:

Slight variation in thickness, fiber mix and color as well as flecks and other slight surface blemishes are an inherent feature of this material and are unavoidable.

Custom colors are available and are subject to minimum order quantities.

Contact LINEA for details

SCREEN DESIGNS

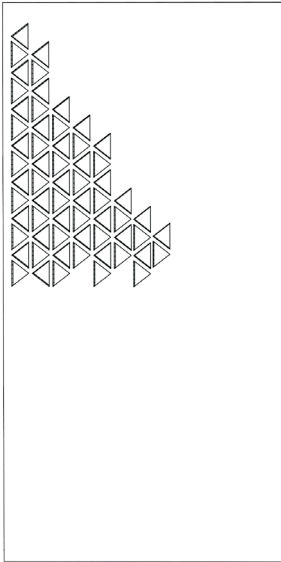

CARNIVAL

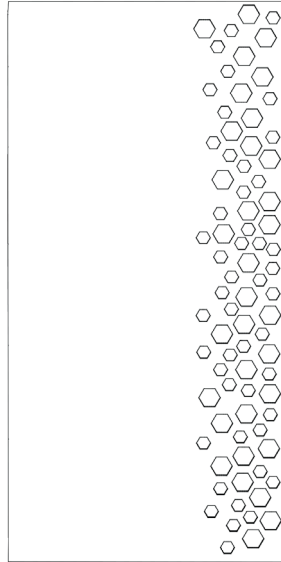

VOLCANIC

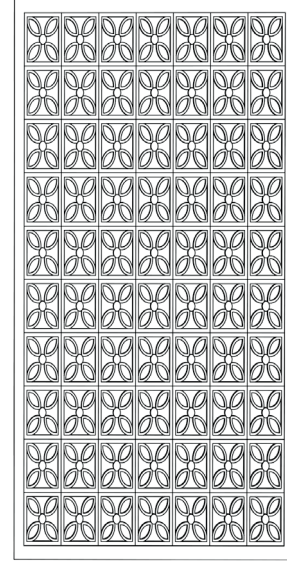

PLANTATION

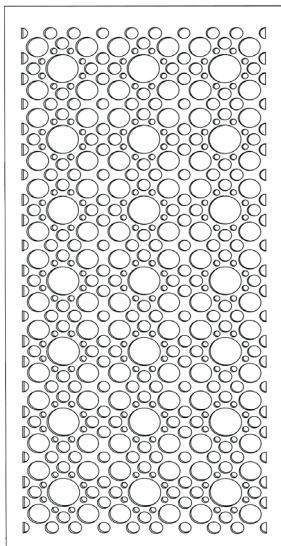

RAINFOREST

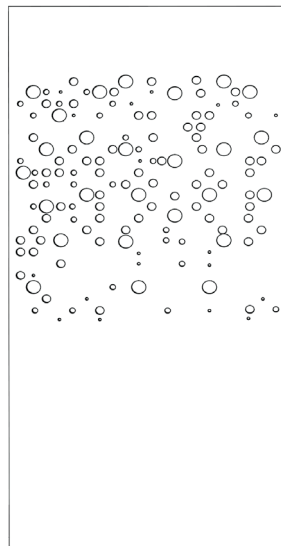

NIGHTLIFE

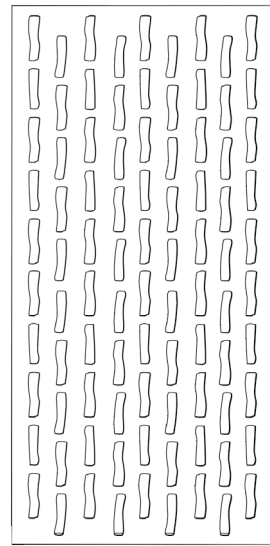

REGGAE

ATTACHMENT METHOD

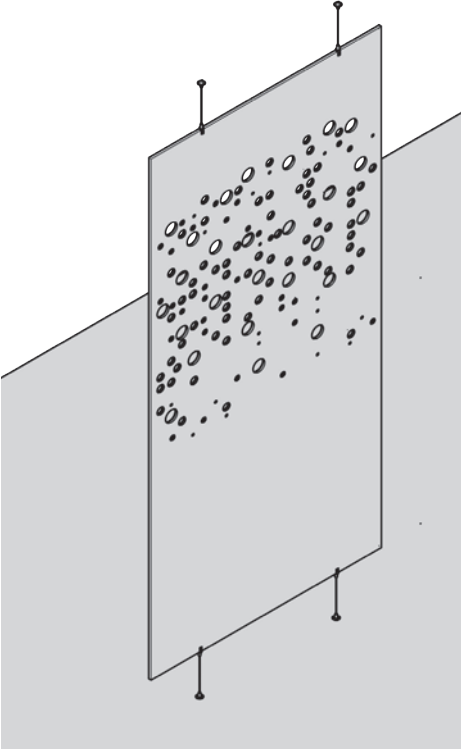

Ceiling & Floor Attachment
SKU: FF-CA-ST-100
 for upper ceiling and Concrete
 Slab with #8 - 2" Screw minimum
 by Installer

T-Bar attachment
SKU:FF-TBA-ST-104

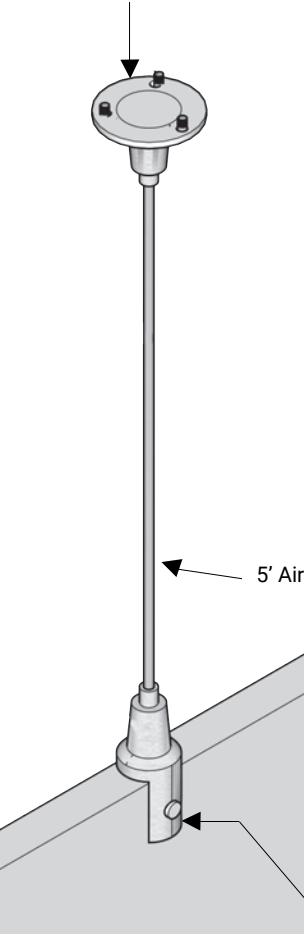
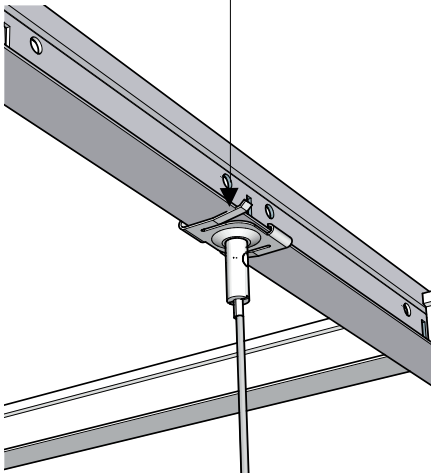

5' Aircraft Cable by LINEA
SKU:FF-TN-400

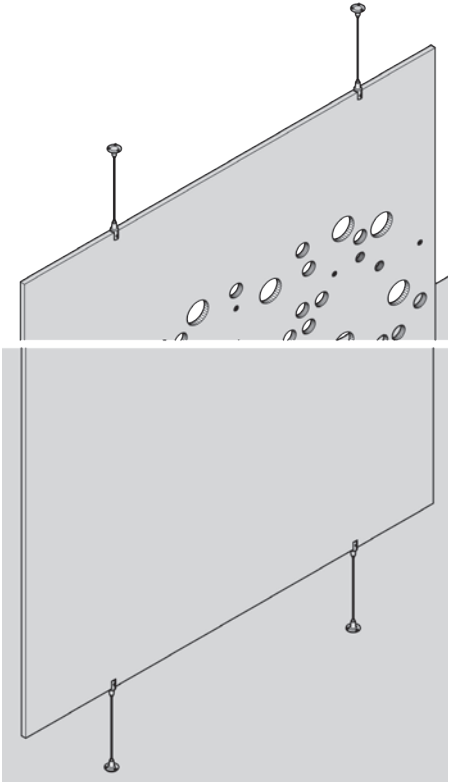
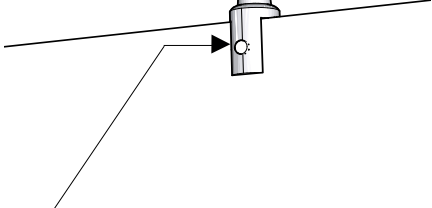

Ceiling Caliper Gripper
SKU: FF-HCG-ST-206
 Optional Caliper Grippers @ 4' oc
 • **SKU: FF-HCG-ST-206**
 • **SKU: FF-CA-ST-101**
 • **SKU: FF-HCG-ST-205**
 No aluminium U-channel required.

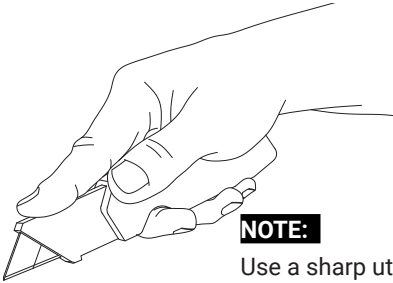

NOTE:
 Use a sharp utility knife to cut
FLEXIFELT panels to suit field
 conditions for MEP fixtures.

*Product information is subject to change without notice.